

acoufelt
making quiet



Swing Ceiling Clouds

Specifications

Application	Ceiling
Composition	100% polyester
Material	FilaSorb™
Recycled content	60% min. rPET
Thickness	12mm +/- 10%
Weight	2400gsm
Dimensions	102 x 610 x 305mm (T x W x H) 102 x 915 x 457mm (T x W x H) 102 x 1220 x 610mm (T x W x H) Lengths – 600 or 1200mm

Sustainability



Made from 60% min. recycled content



Total VOC's less than 0.5 mg/m³ (3rd Party Verified)



Generated using 40% solar energy



Recyclable at end-of-life



Indoor Advantage Gold Certified.



Technical Data

Fire test method	EN 13501-1: 2019
Classification	B-s1, d0
Water vapour sorption method	ASTM C1104-2019 (Procedure A Modified)
Water sorbed by weight	0.20% (results based on a 12mm thick panel)
Total VOC test method	SCS-EC10.3-2014 v4.0 meeting standard CDPH/EHLB Standard Method v.1.2-2017
Total VOC result	≤ 0.5mg/m ³
Colourfastness test method	ISO 105-B02
Rating	6-7

Guarantees

Lead Time	6-8 weeks
Origin	United Kingdom
Warranty against defects	20 years*
Colourfastness warranty	20 years*

*conditions apply

Acoustic Performance

Test method

ASTM C423-09a: Standard Test Method for Sound Absorption and Sound Absorption Coefficients by the Reverberation Room Method

Installation method

Mounting method A

Rating method

AS ISO 11654 -2002: Acoustics - rating of sound absorption - material and systems

Test results

no air gap - 0.45 NRC | 0.25 (H) aw no air gap, Class E

*results are for material only

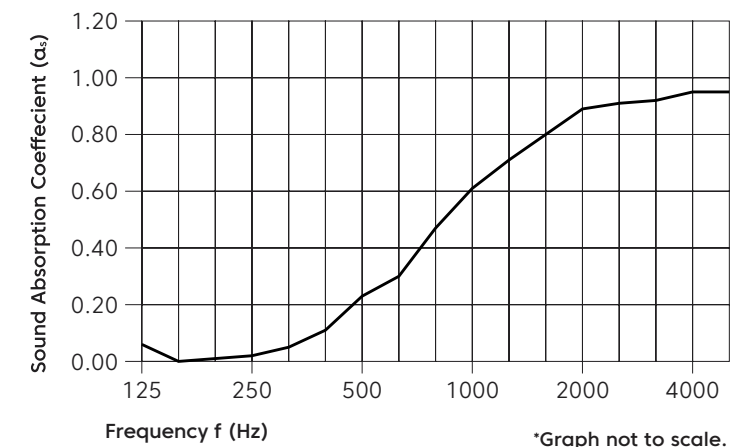

Frequency (Hz)	125	250	500	1000	2000	4000	NRC	Class Rating
12mm - α _s no air gap	0.06	0.02	0.23	0.61	0.89	0.95	0.45	Class E

Performance Indices: **Noise Reduction Coefficient (NRC)** results represent the absorption coefficients measured at the one third octaves bands at 125, 250, 500, 1000, 2000 and 4000 Hz rounded to the nearest 0.05. Acoustic testing has been performed according to the methods mentioned above. Customisation of installation of the product could alter the results.

Design

Sizes

Width x Height	1220 W x 610mm H
	915 W x 475mm H
	610 W x 305mm H
Length	600 & 1200mm
Thickness	102mm

Front Elevation

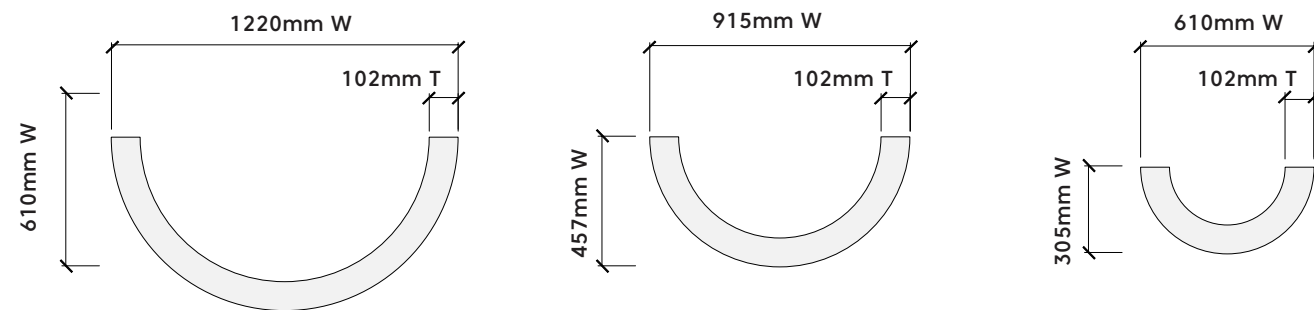

Side Elevation

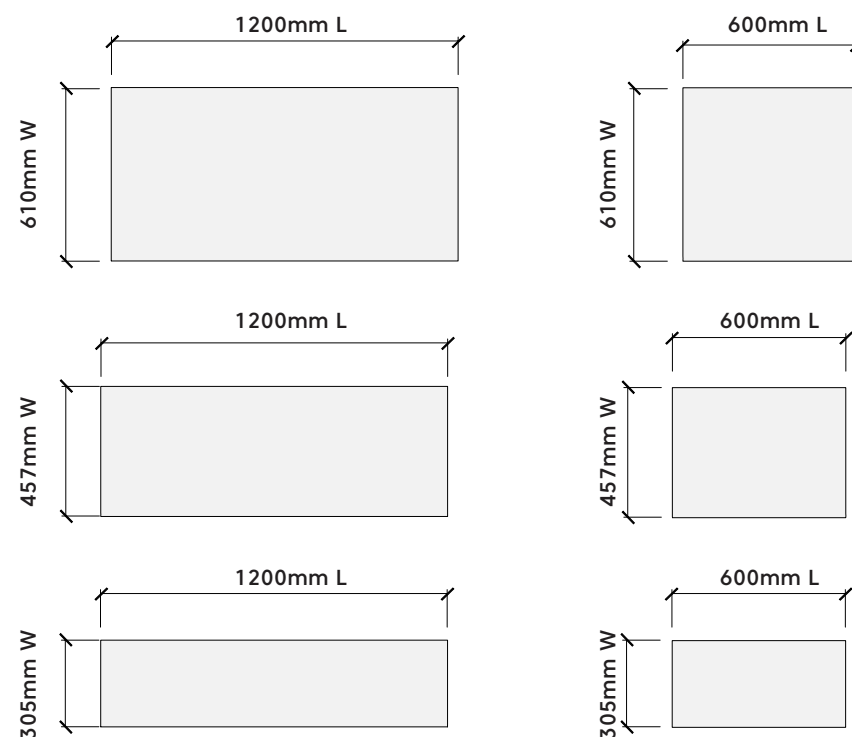

Hardware Spacing

610mm – 305mm on centre spacing

915mm – 457mm on centre spacing

1220mm – 610mm on centre spacing

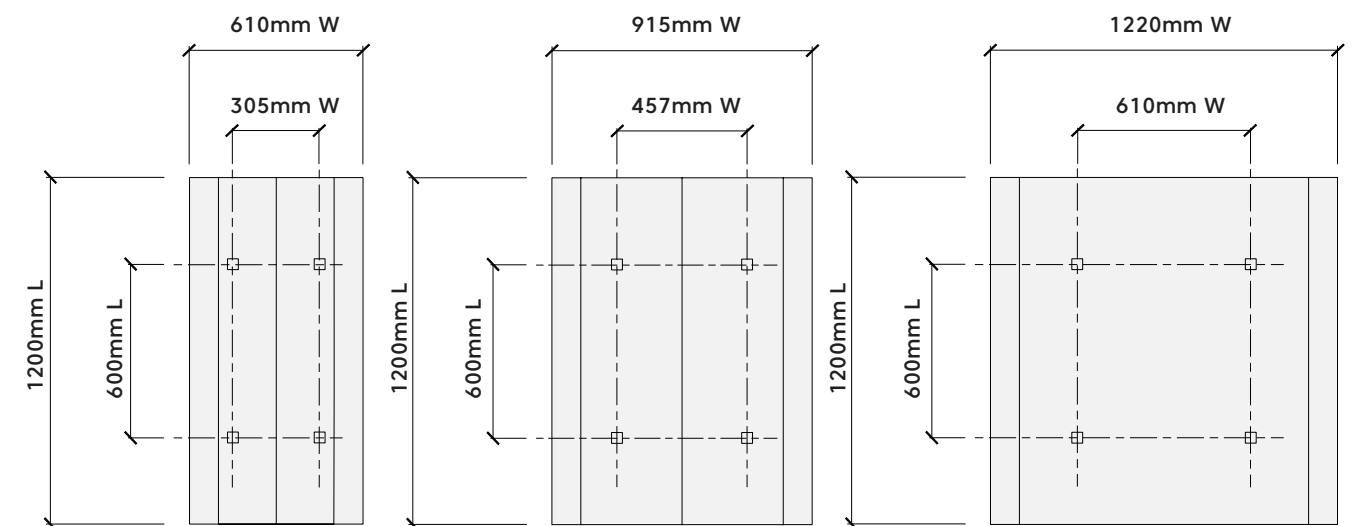
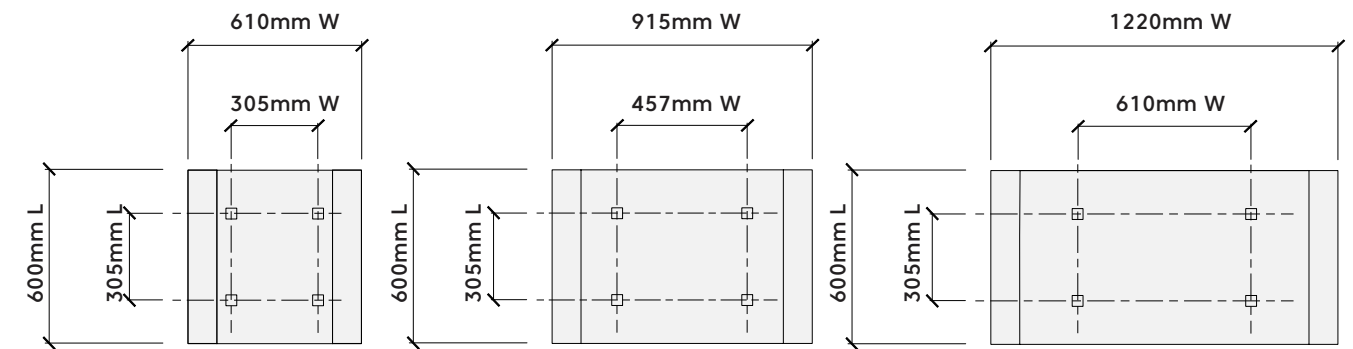

Premier Colourways



Can't find a colour?

We are constantly updating our palette, which includes adding and discontinuing certain colour lines. If you can't find the colour you are looking for, please contact us with your colour request, as we may still have stock available.

WoodGrain Prints



Picket Fence
WQ01

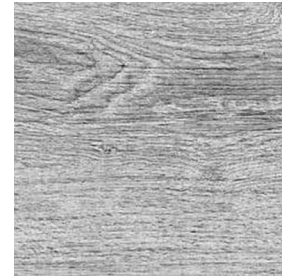

Boat Shed
WQ02



Wine Barrel
WQ03



Log Cabin
WQ04



Barn Door
WQ05

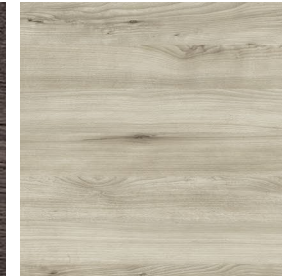

Loft
WQ06

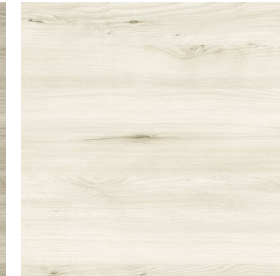

White Elm
WQ07



French Bobbin
WQ08



Charred Larch
WQ09



Boardwalk
WQ10



Antique Chest
WQ11

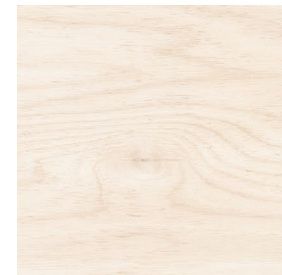

Baltic Birch
WQ12



White Oak
WQ13

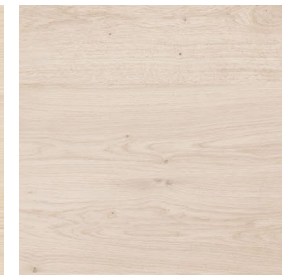

Weathered Slate
WQ14



Nordic Plank
WQ15

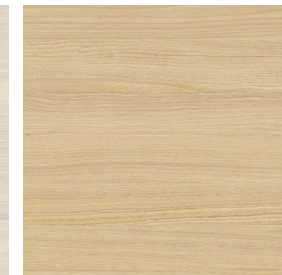

Natural Oak
WQ16

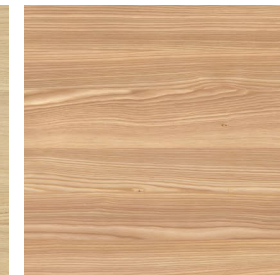

European Larch
WQ17

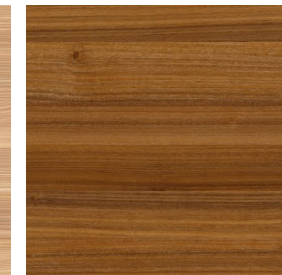

Teak
WQ18

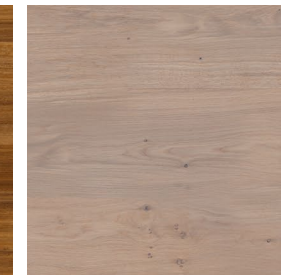

Fumed Oak
WQ19



Black Walnut
WQ20



Driftwood
WQ21



Woodland Fog
WQ22



Petrified Ash
WQ23



Mountain Lodge
WQ24

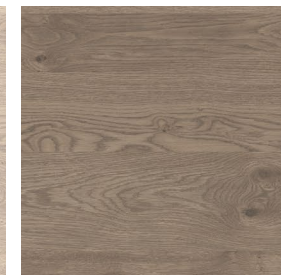

Mocha Legno
WQ25

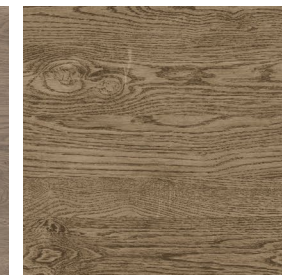

Scorched Timber
WQ26

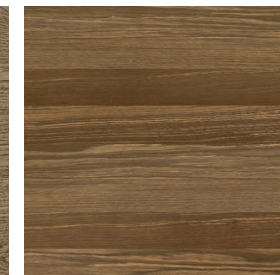

Espresso Oak
WQ27



Shadow Oak
WQ28



Knotty Spruce
WQ29



Lyed Larch
WQ30

Mounting Methods

Cable

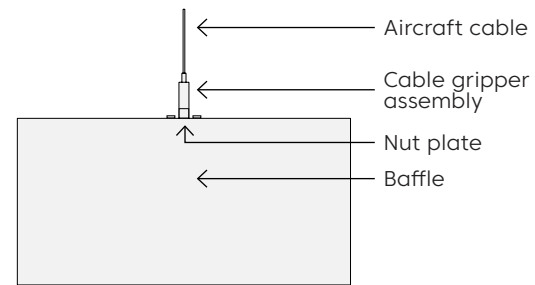

Cable to deck

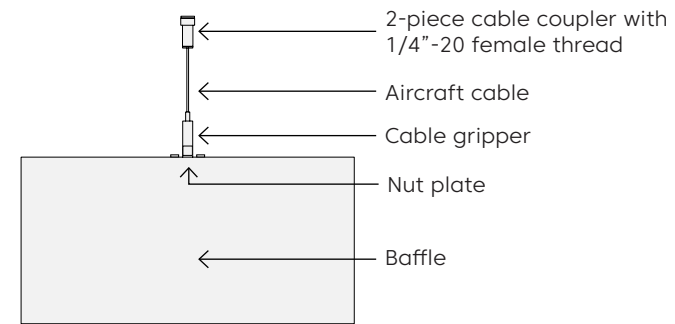

Cable to Unistrut

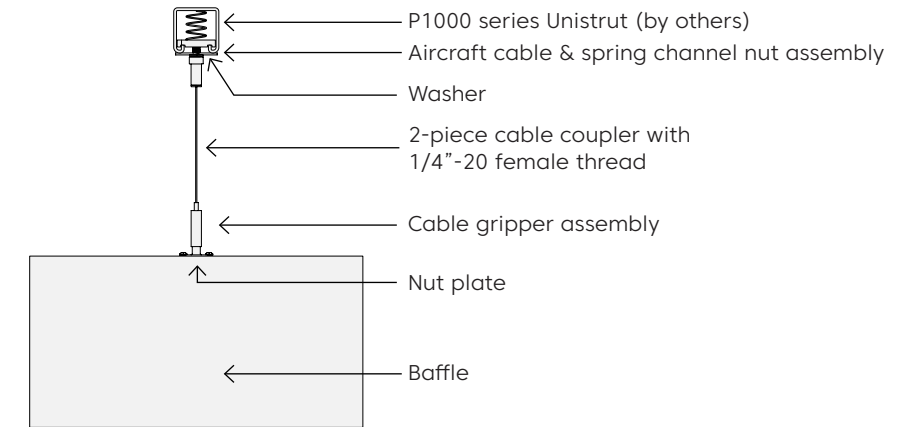

Swivel cable to deck

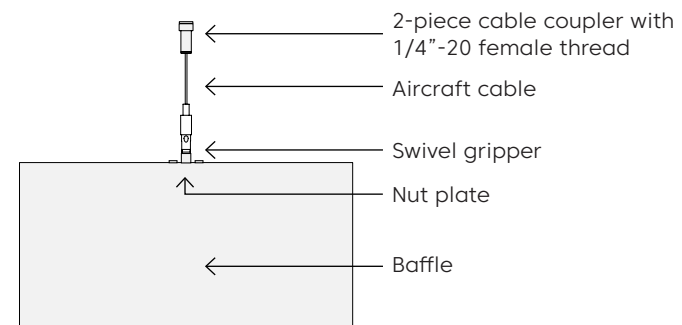

Cable to t-grid

